

**Workshop on**  
**“How to Build your R C Car”**

*Conducted by*  
**Society of Mechanical Engineers**  
**Department of Mechanical Engineering**

On 10<sup>th</sup> November 2022

**Coordinator:**

Dr. A. Arockia Julias, Assistant Professor Sr.Gr., Department of Mechanical Engineering

**Conveners:**

Dr. H. Siddhi Jailani, Professor & Head, Department of Mechanical Engineering

Dr. S. Rasool Mohideen, Professor & Dean, School of Mechanical Sciences

<b>Date</b>	<b>10.11.2022</b>
<b>No. of participants</b>	<b>25</b>
<b>Nature of participants</b>	<b>Students of the School of Mechanical Sciences</b>

## **PREAMBLE:**

The workshop on “**Build your RC Car**” was organized by the Society of Mechanical Engineers of the Department of Mechanical Engineering on 10<sup>th</sup> November 2022. The workshop was coordinated by the faculty in charge Dr. A. Arockia Julias, Assistant Professor Sr. Gr. and the student coordinators Mr. Mohammed Suhail S, Mr. Ajmeer Shan M, Mr. Mohammed Asif and other members of the society.

The objective of the workshop is to provide awareness to the undergraduate students on the various types of RC cars, the components and mechanism used to develop it. The participants registered were assembled in the evening after class and explained the guidelines to be followed, working principles, circuits connections required maneuverability requirements, battery capacity and remote control systems etc. They were also informed about the RC competitions conducted by various institutions and the benefits of participating in such events. The student coordinators motivated the participants by telling their success stories in RC carb competitions.

Demonstration and hands on training on building the RC car was also conducted for the students. About 25 students from Mechanical Engineering department and other departments of the school of Mechanical Science showed interested and build their own vehicle during the workshop. Overall the students got benefitted and motivated by this workshop.

# BUILD YOUR R/C CAR COMPETITION

10<sup>th</sup> NOV 2022

**WORRIED HOW TO BUILD ONE?!**

**JOIN US!**

**WE WILL GUIDE THROUGH YOUR ENTIRE BUILD!!**



**Register For Free**

## Student Coordinators

Mohammed Suhail S 81242 71147

Mohammed Asif S 95142 07403

Ajmeer Shan M 73737 04620

Faculty Coordinator  
**Dr.A.Arockia Julias, AP Sr**



10 NOV 2022

**DIMENSIONS:**

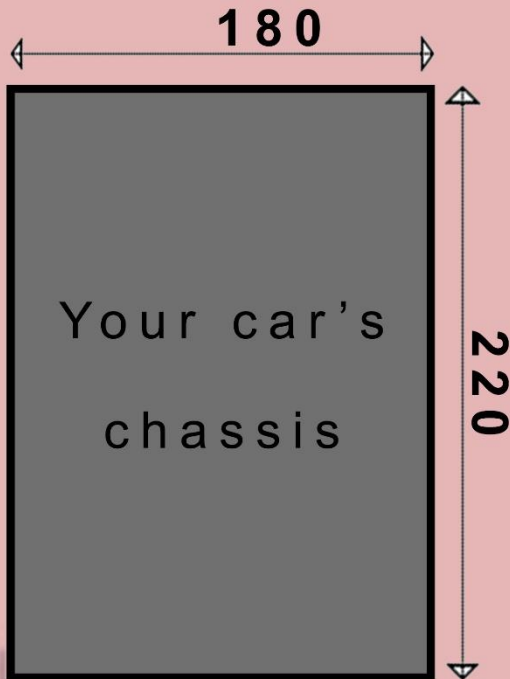

Length :220mm

Breadth:180mm

**DPDT SWITCH  
CONNECTION**

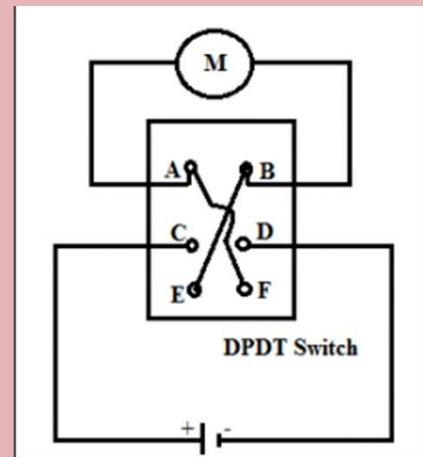

## Training for the Students:



# RC Car build by Students:

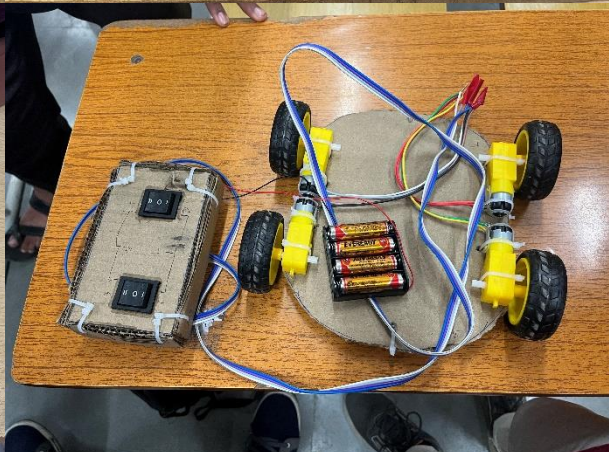
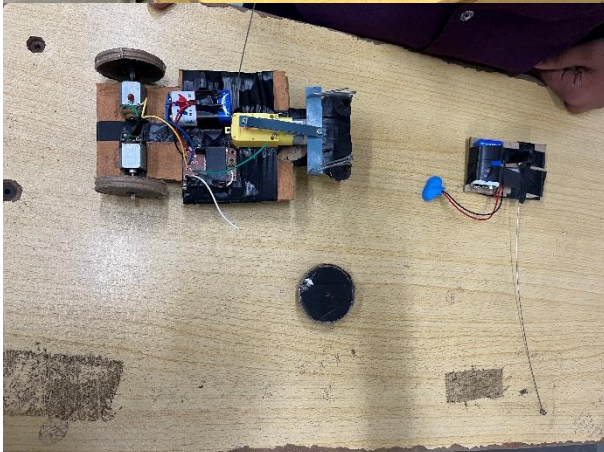
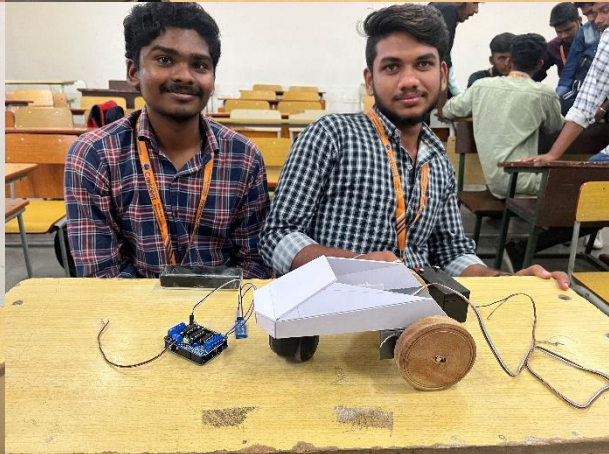
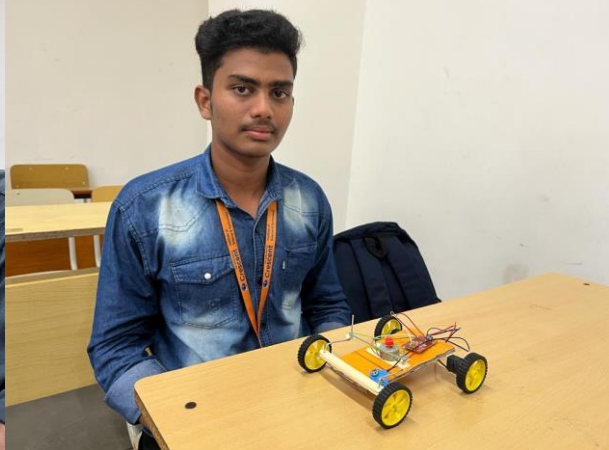
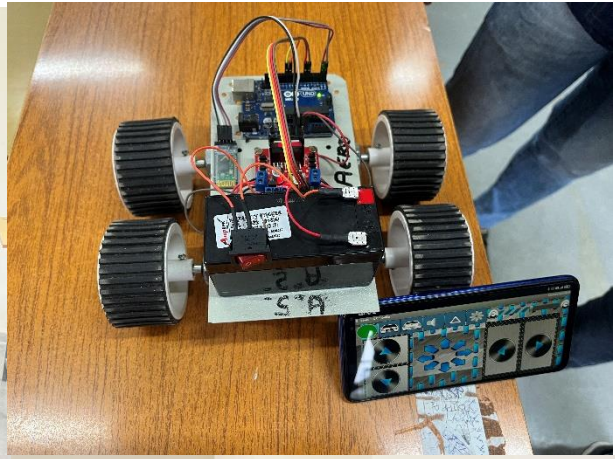
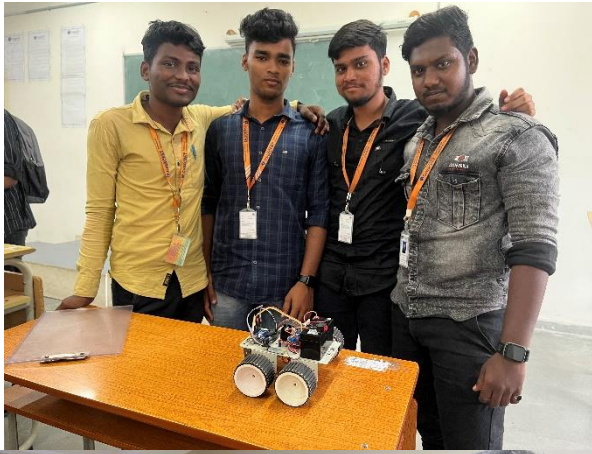

## **Participants Attended:**

<b>SI</b>	<b>Name</b>	<b>RRN</b>	<b>Department</b>
1	Mohammed Basharath M.A	210021601051	Mechanical
2	Mohamed Aathil S	210021601035	Mechanical
3	M.L.Kadhir Imran	200021602014	Mechanical
4	S.Gowtham	200021602011	Mechanics
5	M.Mohammed Adullah	200021602045	Mechanical
6	Rohan.S	200021601026	Mechanical
7	K. Mohamed Adnan Adil	200021601011	Mechanical
8	T.Mohamed Fazil	200021601013	Mechanical
9	Abdul Zawahirudeen. S	200021601001	Mechanical
10	Ananthakrishnan. M	200021601004	Mechanical
11	Ponmudi MP	190021601004	Mechanical
12	Gokul Raam G	200021601008	Mechanical
13	Abdul Rasheed	210021601003	Mechanical
14	SHABBEER SHARIEFF A	210096102002	Aeronautical
15	SARTHAJUDDHIN M	210096102001	Aeronautical
16	AMEER KHAN ARY	210096102005	Aeronautical
17	SHAJAKHAN R	210096102003	Aeronautical
18	Mohamed Asif	210021601037	Mechanical
19	J Sirajudeen	210021601079	Mechanical
20	Arwin	200021602005	Mechanical
21	Akash	200021602001	Mechanical
22	Mohamed Aadhil B	210021601058	Mechanical
23	Mohammed jasim	210021601055	Mechanical
24	Agnel Magnus	210021601005	Mechanical
25	SANTHOSH	210021601074	Mechanical
26	VIGNESH KATHIRVELAN	210021601043	Mechanical